

ON-CENTER LINEAR LIGHTING WITH XAL
Layout Guide

Inspiring Great Spaces™

Armstrong®
CEILING SOLUTIONS

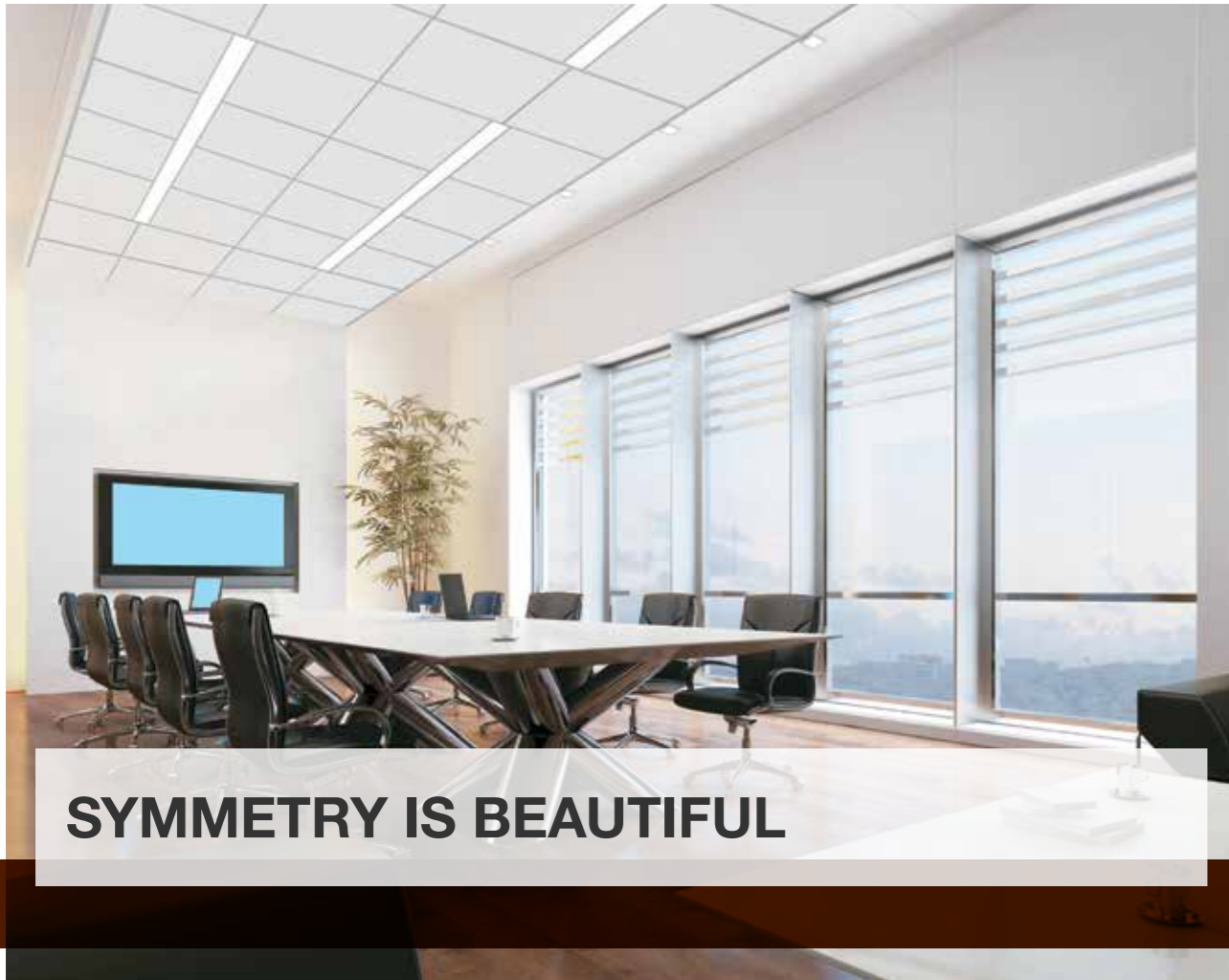

1 Design your layout

Select from one of our standard layouts or create your own configuration

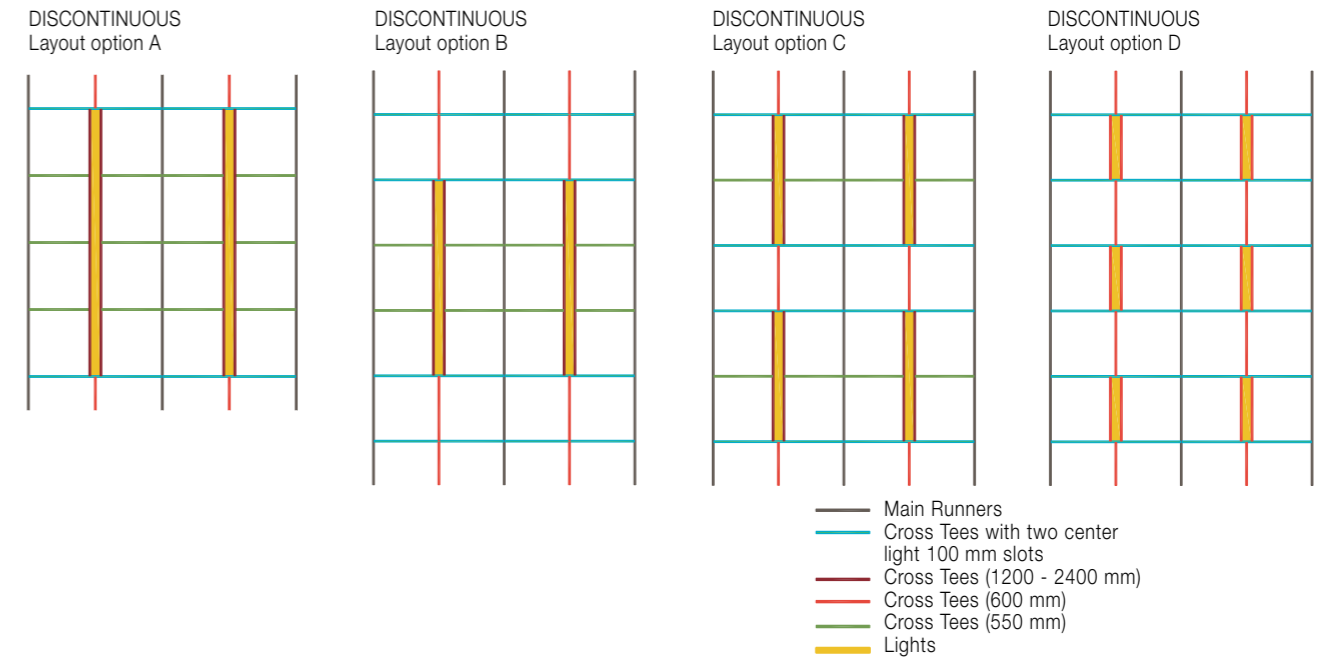

2 Choose your panels



Armstrong and XAL Lighting are making it easier than ever to create inspiring ceiling designs with higher ceiling heights, zero plenum interference, and on-center discontinuous layouts that provide clean, modern aesthetics.

Our integrated system design allows the new high-performance XAL LENO Zero Plenum LED luminaire to be installed from below to eliminate ceiling rework when specified with factory-finished Armstrong ceiling panels and the Prelude 15 XL² suspension system.

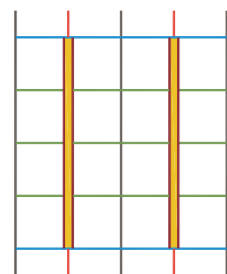

1

Design your layout



2

Choose your panels

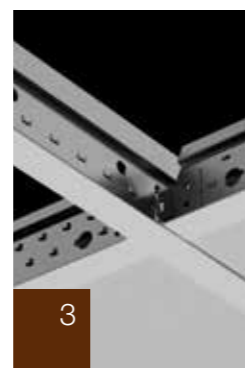

3

Choose a compatible suspension system

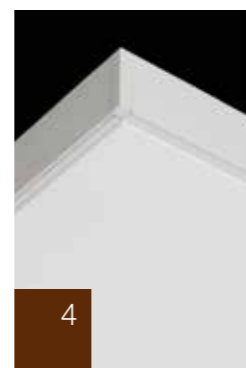

4

Choose your perimeter treatment, transitions and accessories

PANELS - PERFORMANCE SELECTION

	Absorption α_w	Absorption Class	Attenuation D_{nfw} (dB)	C2C	Recycled Content (%)	VOC	Light Reflectance	Clean Room	Scratch Resistance
ULTIMA+	0.70(H)	C	36	Bronze	50	A+	87	ISO 5	Yes
ULTIMA+ OP	1.00	A	25	Bronze	36	A+	87	ISO 5	Yes
PERLA OP 0.95	0.95	A	25	Bronze	36	A+	85	ISO 5	No

30 YEAR system guarantee

Recyclable

A2-s1,d0

Product handling & durability

95%RH

Dry cloth, vacuum

Damp sponge

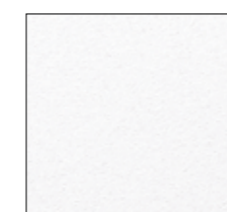

ULTIMA+

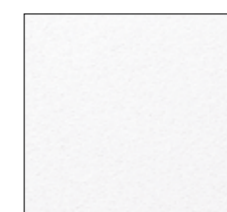

ULTIMA+ OP



PERLA OP 0.95

All measurements in millimetres. All sizes are nominal.

PANELS - ITEM NUMBERS AT-A-GLANCE

Edge profile	Dimensions	ULTIMA+	ULTIMA+ OP	PERLA OP 0.95
MICROLOOK 90	600 x 550	7713M4	7714M4	5186M4
	600 x 600	7674M4	7685M4	5179M4

Special products available on request.

3 Choose your suspension system

PRELUDE 15 - XL² SUSPENSION SYSTEM

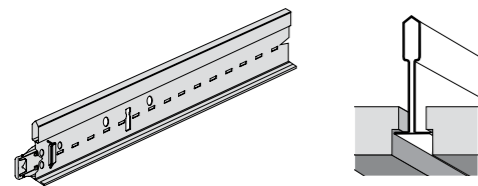

Special products available on request.



ACCESSORIES

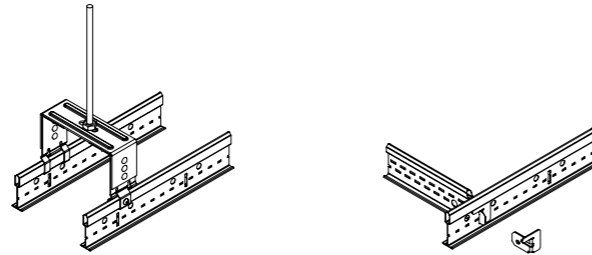

Service integration hanger bracket

Single tee Adapter Clip STAC

SUSPENSION SYSTEMS - ITEM NUMBERS AT-A-GLANCE

Item n°	Description	Length	Dimensions
30 40 33 A	Prelude 15 - Universal Peakform Main Runner	3600	3600 x 15 x 43
30 30 32	Prelude 15 - XL ² Cross Tee slotted at 300mm and two center light 100mm slots	1200	1200 x 15 x 38
30 05 32	Prelude 15 - XL ² Square Bulb unslotted	550	550 x 15 x 38
30 20 33 B	Prelude 15 - XL ² Peakform Cross Tee unslotted	600	600 x 15 x 38
30 30 33 B	Prelude 15 - XL ² Peakform slotted at 300mm	1200	1200 x 15 x 38
30 34 32	Prelude 15 - XL ² Square Bulb slotted 600mm, 1200mm	1800	1800 x 15 x 38
30 09 32	Prelude 15 - XL ² Square Bulb slotted 600mm, 1200mm, 1800mm	2400	2400 x 15 x 38
A 1100	Service integration hanger bracket	100	100 x 37 x 75
STAC	Single Tee Adapter Clip		



4 Choose your perimeter treatment

- A. Wall to Wall installations
- B. Cloud/Floating installations
- C. Material transitions in the ceiling plane

A. SELECT PERIMETER ANGLE AT WALL

Shadowline

- T 1508 HB

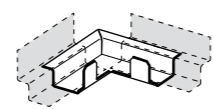
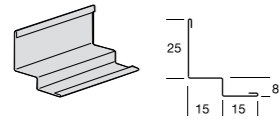

A 332 G - Inside corner

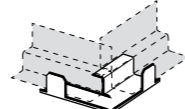

A 333 G - Outside corner

Perimeter angles

- T 1924 HD

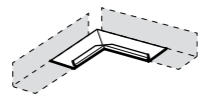
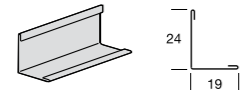

A 328 G - Inside corner 19 mm

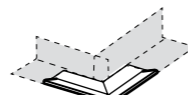

A 329 G - Outside corner 19 mm

- T 1932 HA

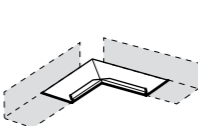
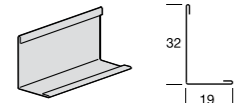

A 330 G - Inside corner 24 mm

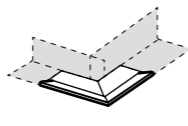

A 331 G - Outside corner 24 mm

- T 2424 HD

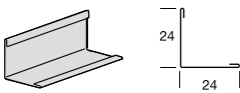

A 157 - Perimeter fill-in clip for 15 mm grid - MicroLook 90

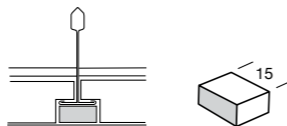

B. SELECT PERIMETER TRIM AT FLOATING EDGE

Axiom® Profile

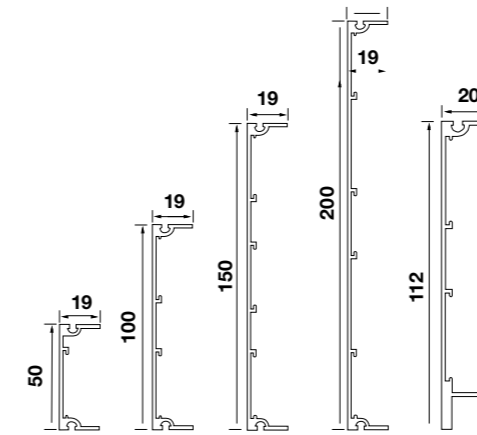

- 52 42 06 G - AXIOM Profiles 50 mm
- 54 42 06 G - AXIOM Profiles 100 mm
- 56 42 06 G - AXIOM Profiles 150 mm
- 58 42 06 G - AXIOM Profiles 200 mm
- 55 14 11 G - AXIOM Vector Profiles 112 mm

Also available in RAL 9010.

C. SELECT TRANSITION COMPONENTS

■ Axiom Transitions for MicroLook 90 (full tile)

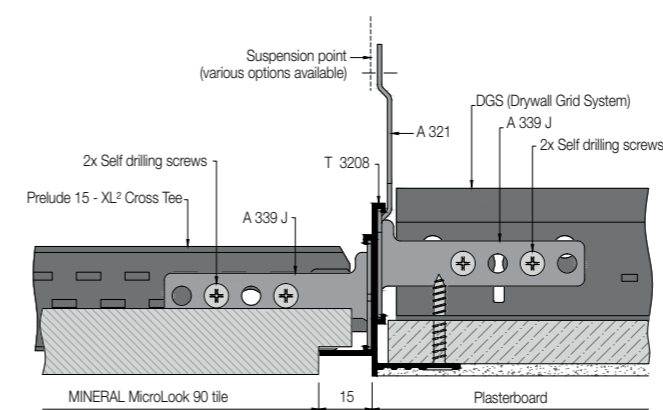

■ Axiom Transitions for MicroLook 90 (cut tile)

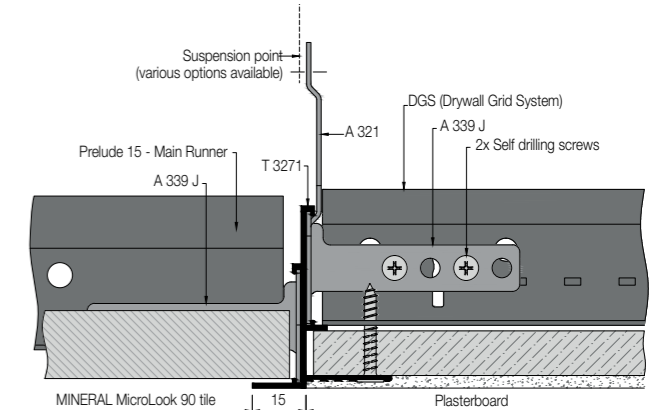

■ Axiom Transitions Shadowline angle (cut tile)

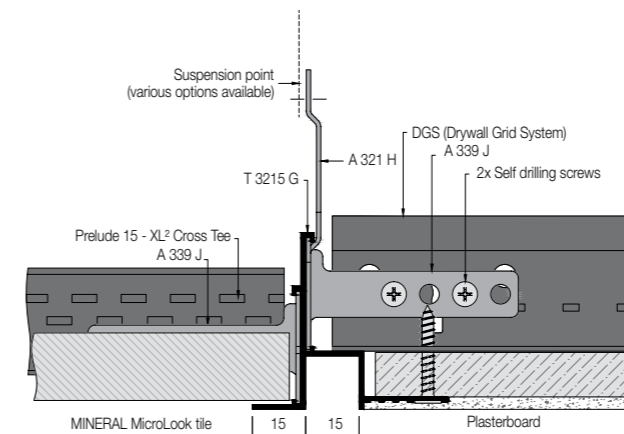

ACCESSORIES

SERVICE INTEGRATION HANGER BRACKET ALLOWS FOR DISCONTINUOUS LIGHT CONFIGURATION

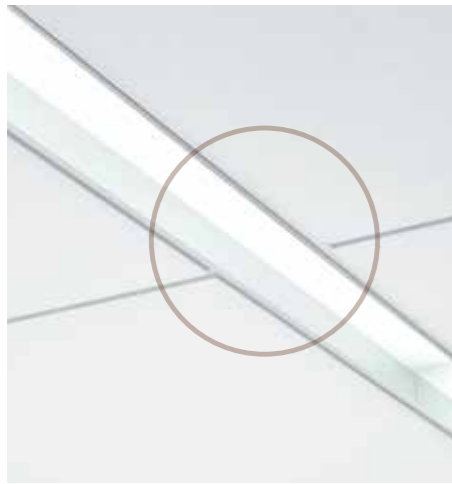

Lighting up to 2400mm

- Create a sleek ceiling design with ribbons of light
- Easy installation

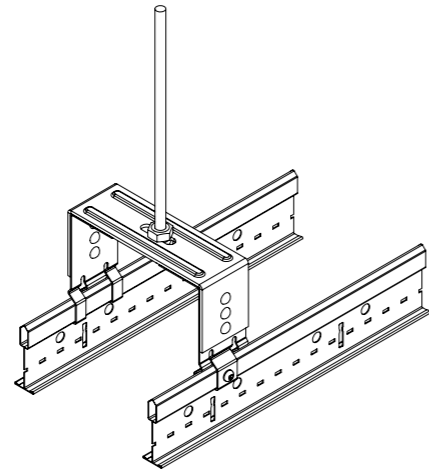

CLIPS

Single Tee Adapter Clip STAC

Create a playful design with off module lighting.
Seismic tested.

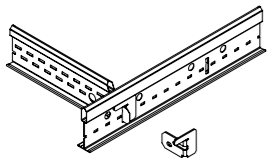

Universal Retaining Clip A 7890 G

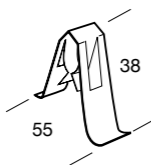

SYSTEM LAYOUT & COMPONENTS

DISCONTINUOUS - LAYOUT OPTION A

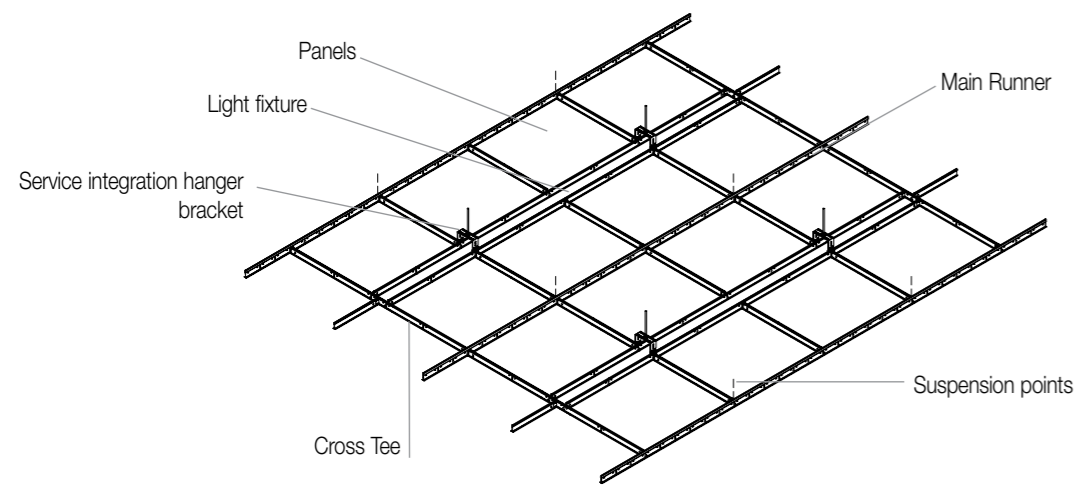

DISCONTINUOUS - LAYOUT OPTION B

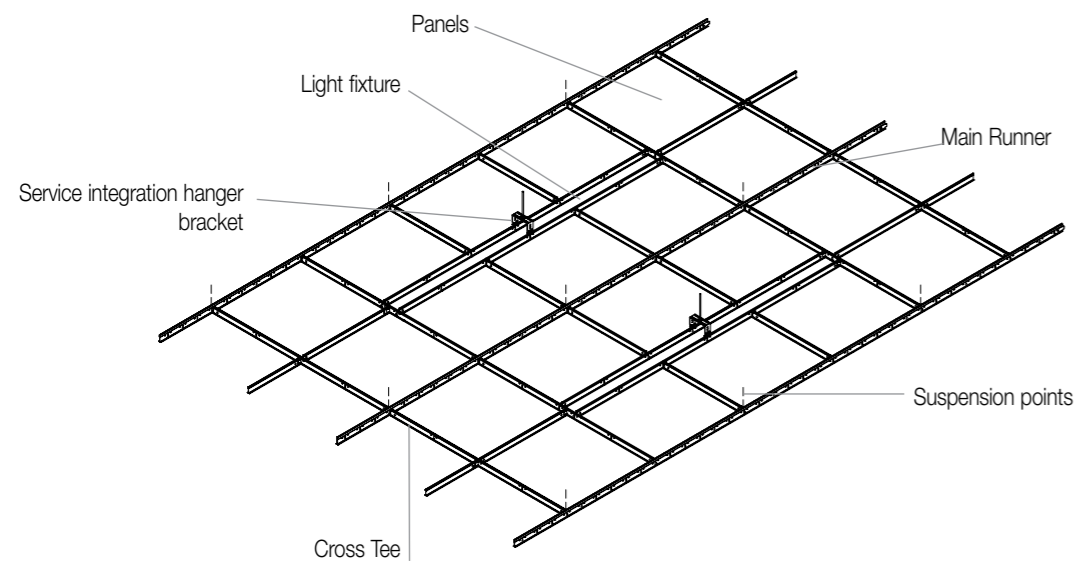

DISCONTINUOUS - LAYOUT OPTION C

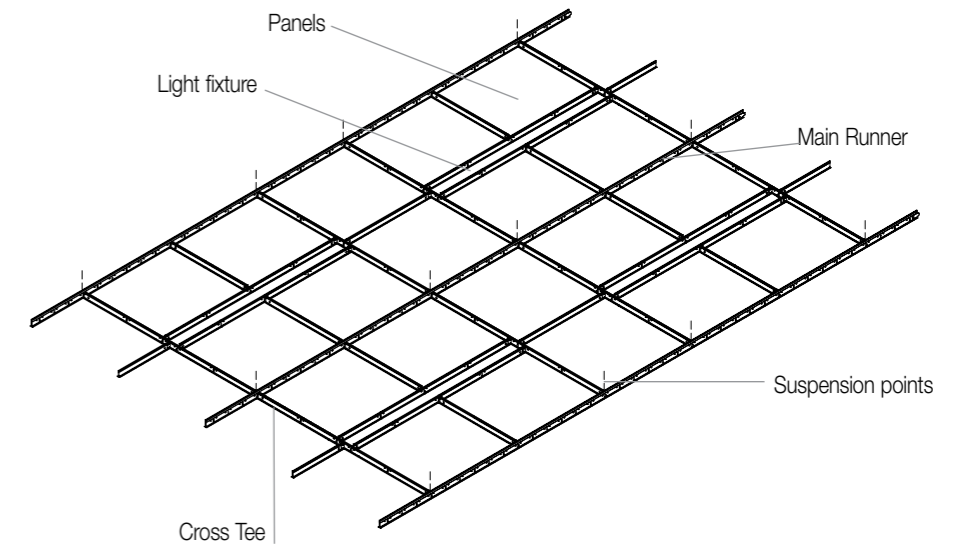

DISCONTINUOUS - LAYOUT OPTION D

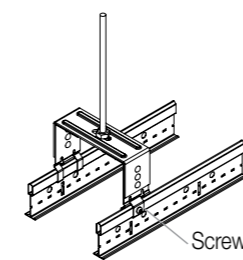
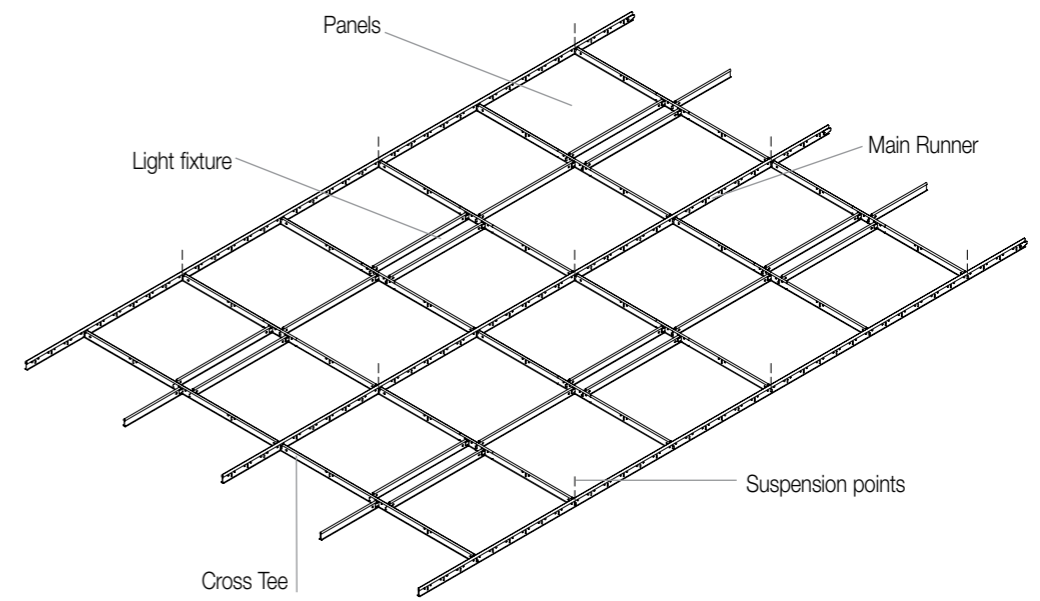

Service integration hanger bracket

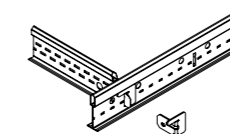

Single Tee Adapter Clip
STAC



Agency: GECKO- 08/2016
Armstrong World Industries - RCS Besançon B 784 131 575 Printed on free chlorine paper.

Advisory note

All photographic and design elements supplied in this brochure do not necessarily reflect any recommendation by any of the companies named in this brochure as to the proper use or recommended methods of installation of suspended ceilings and are supplied only as informative material. For technical reasons in printing, differences may appear between colours printed in this brochure and the actual product. The choice of colours should always be made from a sample of the product. All statements and technical information contained in this brochure, or any publication of the companies named in this brochure, relating to Armstrong ceilings are based on results obtained under laboratory test conditions. **It is the responsibility of the user to verify with the seller of the products in writing that such statements and information are appropriate to the specific use intended.** Sales of the products and liability of the selling companies are in accordance with the terms and conditions of sale of the selling company. All product specifications are subject to modifications without prior notice.

www.armstrongceilings.co.uk

www.armstrongceilings.co.za

www.armstrongceilings.ie

Inspiring Great Spaces™

Armstrong®
CEILING SOLUTIONS