



# 4200

shower curtain track  
for care institutions

---

**The standard in  
healthcare**





# 4200

## shower curtain track practical & versatile

The Goelst shower curtain track 4200 is an ideal rail for your shower curtain. The rail can be fitted with suspension hangers to be used in hospitals and care institutions. The Goelst 4200 can even be mounted without a suspension hanger between two walls up to a length of 180 cm. A very popular rail with many applications, such as in the care sector and residential homes.

- The ideal track for all shower curtains.
- Easy to bend and exceptional quality.
- Can be forward or reverse bent in different radii.
- Silent and smooth running, also round bends.
- Usable with LRS gliders.



### Standard colours



High quality, wear-resistant coating, highly colourfast, UV-resistant.  
Other RAL colours & special coatings on request.

### Features

<b>Material:</b>	aluminium
<b>Colour:</b>	white, natural anodised
<b>Dimensions:</b>	18 x 21 mm
<b>Weight profile:</b>	274 gr/m <sup>1</sup>
<b>Mounting:</b>	wall or ceiling

# Profile specifications

## Aluminium profile:

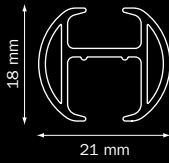

## Colours with RAL code and lengths (m):

	RAL	4	5	6	7
white	9010			•	
natural				•	

## Mounting surface:

- wood
- masonry/concrete

## Bracket type:

- ceiling bracket
- wall bracket
- spacer bracket

## Bending:

bending radius	bending tool
R 10 cm	1015
R 15 cm	1015
R > 100 cm	1018

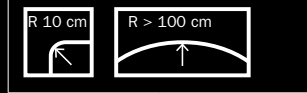

# Mounting

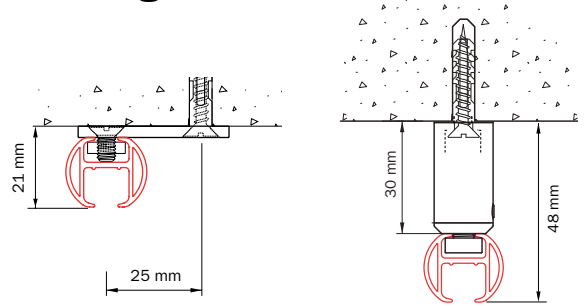

Ceilingmounting 4200 with ceiling bracket 5153

Ceilingmounting 4200 with suspension hanger 4254

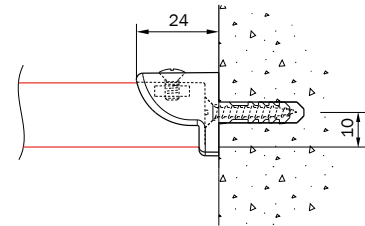

Wall mounting 4200 with wall bracket 4249

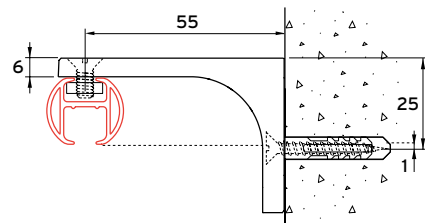

Mounting 4200 with wall bracket 5140

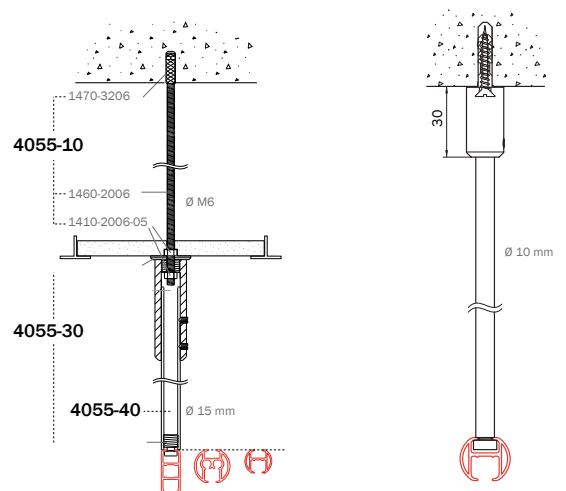

Ceiling mounting 4100, 5100 or 4200: threaded rod set 4055-10, suspension hanger tube 4055-40 and with fixing set 4055-30.

Ceiling mounting with 4255



## Application example

Standard shower rail situations and suspension hanger positions

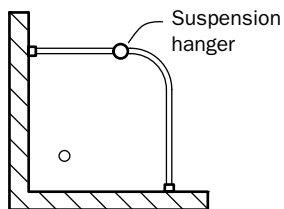

L-shaped (shower)

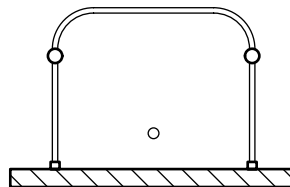

U-shaped (shower)

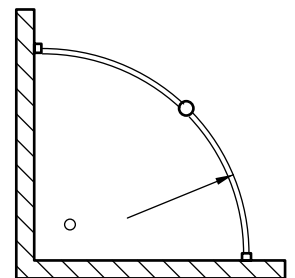

Special (for example corner baths)

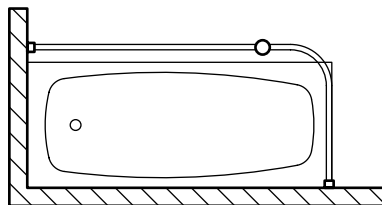

L-shaped (bath)

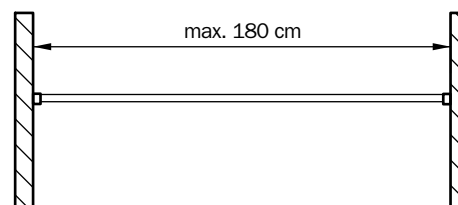

Straight rail

## Specification guide

### Material

- Aluminium EN AW-6060-T66.
- Anodised in accordance with the Qualanod standard.
- Powder coated in accordance with the Qualicoat standard.

## Standard parts

### Curtain transport



**4001-M-N-60**  
end stop metal with eye natural and RVS hook



**4003**  
spring stop plastic requires punch hole white



**4007-60**  
rotating glider with ss hook, white / grey

### Mounting



**4249**  
wall bracket white / grey

### Accessories

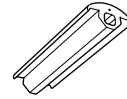

**4145-050**  
dust cover reel 50m white / grey

## Optional parts

### Curtain transport



**4001-M-N**  
end stop metal with eye natural



**4002**  
end stop metal



**4007**  
rotating glider white/grey / silver / black



**4007-60-LRS**  
rotating glider LRS grijs / rotating glider LRS red



**4007-70**  
rotating glider with ring, white

### Mounting

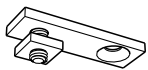

**5135**  
ceiling bracket white / natural metallic



**4254**  
mini suspension hanger 3cm white / natural metallic / black



**4255**  
suspension hanger 50, 100, 150 cm white, natural



**4055-10**  
threaded rod M6 with plug and 2x nut M6, 0-100 cm / 101-200 cm



**4055-30-SYST-10**  
susp.hanger mount.set susp. ceiling, white / natural



**4055-30-10**  
susp. hanger mounting set white / natural



**4055-30-LRS-51**  
susp. hanger mounting set LRS 5100



**4055-40**  
susp. hanger tube 50cm natural, 50 / 100 / 150 cm, one side threaded white / natural / black

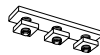

**5130**  
connecting bridge white / natural metallic



**5140**  
wall bracket white / grey

### Accessories



**4253**  
end cap plastic white / grey



**4253-A**  
aluminium end cap white / natural metallic



**5152**  
connecting bridge naturel



**4159-A**  
threaded insert without foot white

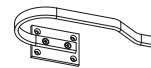

**4170**  
curtain holdback with fixing plate white / natural

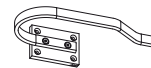

**4170-ISO**  
curtain holdback nat. fixing plate, isolated white / natural

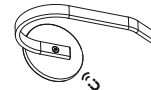

**4170-M**  
curtain holdback, magnetic fixing, white



**Goelst UK Ltd**

Crimple Court | Hornbeam Park | Harrogate | HG2 8PB  
Tel 01423 873002 | Fax 01423 874006 | [info@goelstuk.com](mailto:info@goelstuk.com) | [www.goelst.co.uk](http://www.goelst.co.uk)