



ECONOBOOST EB SERIES COLD WATER BOOSTER SET

**INSTALLATION, OPERATION
& MAINTENANCE
DOCUMENTATION**

**STOKVIS ENERGY SYSTEMS
34 CENTRAL PARK ESTATE
34 CENTRAL AVENUE
WEST MOLESEY
SURREY
KT8 2QZ
TEL: 0208 783 3050
FAX: 0208 783 3051
E-MAIL: info@stokvisboilers.com
WEBSITE: www.stokvisboilers.com**

General Installation

Site Location

During off loading and positioning of the booster set care must be taken only to lift via the base frame and not the pipework, pumps or vessel/s.

The unit location should be undercover, dry and freely ventilated. Protection from frost must be ensured.

Provision should be made for the disposal of system drained water.

Reasonable access to all parts of the set and adequate service work space must be provided. Provision for lifting equipment is recommended for units incorporating large pumps.

The floor base should be firm and level in all directions. Isolation of the set if required should be anti-vibration feet or matting beneath the frame together with pipework flexibles.

All system pipework should be aligned and self-supporting preventing any strain or distortion within the unit.

Water Supply

The stored water should be clean and free from any foreign materials. There should be nothing suspended or dissolved to block or wear the pump internal components.

The water storage tank should provide all the pumps with a fully flooded suction (with the exception of self-priming sets) at all times irrespective of water level within the tank.

All self-priming sets should be fitted at the water source with a good quality foot valve complete with stainless steel strainer, all suction pipework runs should be sited to avoid any air pocket traps and be fitted with at least one positive/negative automatic air vent.

Pipe sizing should be to suit length of run and booster set net positive suction head requirements.

Isolating Valves

If final isolating valves are not supplied with the unit we strongly recommend the fitting of these and unions to facilitate any service work necessary.

Pipe work connections

The suction pipe work from the water tank should be connected to the lower manifold at either end, use the blanking cap for the manifold end which is not required.

Connect the discharge pipe work from the building into the top header at either end or both ends as required, blank off either end which is not used.

We recommend that an isolation valve and union are fitted on both headers to aid commissioning and service work in the future.

Electrical

Connections to unit

The supply should be brought to the set with suitable trunking or armoured flexible cable (depending on current rating of set), with trunking we recommend that the final metre is converted to flexible conduit to avoid any undue stress or fatigue to the unit.

All supply cables should be sized accordingly to accommodate any voltage drop due to long cable runs for all pumps running simultaneously.

Voltage at the unit should be to the stated supply voltage on the specification. A neutral supply is required for all panels.

It is recommended that an independent isolator is fitted adjacent to the unit.

Supply fuses should be rated for the size of the pump motor multiplied by the number of pumps within the booster set. (Please refer to specification for Kw and F.L.C. details).

The control panel when fitted has its own individual pump protection.

All equipment should be earthed.

After priming of the unit, pump rotation must be checked and phases changed if necessary to prevent damage and lack of pump performance. Rotation should also be checked after any electrical maintenance work within the building.

All connections should be performed by a competent electrical engineer conversant with the panel wiring diagram and current UK regulations.

Start Up

Air Checks

Before suction isolation valves are opened all hydraulic accumulator/s air pressures should be checked (if fitted) and adjusted using a car tyre pressure gauge, foot pump or oil free compressor. Access is via the Schrader valve under the cover cap. Please refer to the vessel label or booster set specification sheet for pressure required.

Priming

After flooding the suction line all the pumps should be primed and vented. On vertical multistage pumps these should have individual vent plugs loosened to allow air purging and water flow to each priming point, this may have to be repeated if poor pump performance is experienced due to trapped air pockets.

On certain horizontal end suction pumps these too may have a vent plug, but if not fitted air should be allowed to evacuate via a suitable point of the discharge pipework, e.g. a drain cock, tap etc.

NEVER RUN ANY PUMPS EVEN TO CHECK ROTATION BEFORE COMPLETE PRIMING IS ACHIEVED.

Check the operation of the storage tank low level float switch where fitted

All units are wet tested and set before despatch and should only need slight pressure if at all, owing to differing site suction conditions. For pressure adjustments please refer to the Easymat inverter manual.

Do not adjust the pressure setting without consulting the office as each model can only work in a certain band width.

Maintenance

Booster sets require very little general maintenance, listed below are quarterly and yearly check schedules.

Quarterly

The hydraulic accumulator should have its internal air charge checked and adjusted to the correct pressure. It must be stressed that this is only to be performed after switching off the booster set, isolating the accumulator and draining all water present from the internal storage, to obtain a correct pressure reading.

The whole set should be observed for any leaks, particularly the pump shaft seals and the valve glands, if found please contact us for a service.

The pumps should be noted for any deviations to their smooth running and performance, again please contact our service department for any assistance required.

If the unit has not been operational for a long period all pumps should be vented as described in the start up information.

If not in use during the winter period and there is any chance of freezing, drain all pumps and pipework and cover with a suitable frost protection covering. Ensure full venting before start up.

Yearly

All quarterly checks are to be performed.

All pumps should have a full load current, and windings test to ascertain pump motor condition.

The pressure settings should be checked and adjusted as required.

All control panel internal components should be observed, (After isolation) and fuses changed, terminals tightened, All overloads should be tripped and reset to check correct operation.

Non-return valves should have a visual and audible inspection for general wear and sealing.

All gauges (where fitted) are to be inspected for operation and replaced as required.

Electrical cables and conduit are to be checked for cuts or chaffing and to be replaced as necessary (After unit isolation).

It is recommended that all yearly checks are carried out by our engineers and service contracts are available on request.

Frequency converter

EASYMAT 5MM

EASYMAT 9,2MM

EASYMAT 5MT

EASYMAT 7,5MT

EASYMAT 9,2MT

OPERATING INSTRUCTIONS

1. Introduction
2. Special warnings regarding the frequency converter
3. Types
4. Operating conditions
5. Construction
 - 5.1. Technical features
 - 5.2. Pushbutton functions
 - 5.3. Interface
 - 5.3.1. System icons
 - 5.3.2. Display area
 - 5.3.3. Operating icons
 - 5.4. Submersible pump applications or high long cables
6. Installation
7. Electrical connection
 - 7.1. Power supply line
 - 7.2. Motor connection
 - 7.3. Pressure transducer
 - 7.4. Cascade mode
 - 7.4.1. Cascade mode installation
 - 7.4.2. Cascade mode electrical connection
 - 7.4.3. Cascade connection with 2 variable speed pumps
 - 7.4.4. Cascade connection with 1 variable speed pump and 1 fixed speed pump
 - 7.4.5. Cascade mode programming
 - 7.4.6. Cascade mode plant starting
 - 7.5. Float switch connection
 - 7.6. Remote alarm connection
8. Dry-running protection
9. Parameters
 - 9.1. Parameters of pump status
 - 9.2. Programming parameters
10. Programming
 - 10.1. PASSWORD Insertion
 11. Parameters to check when starting up the unit.
 - 11.1. Vessel pressure
 12. Plant starting
 - 12.1. Changing direction of rotation
 13. Operation
 - 13.1. Quick set point modification
 14. Use of megaohmmeter
 15. Maintenance
 16. Accessories
 - 16.1. RA 100
 - 16.2. Pipe housings Kit
 - 16.3. Union kit
 17. Disposal
 18. High length cables EASYMAT applications
 - 18.1. Reduction of the electromagnetic noise emissions
 - 18.2. Reduction of the electromagnetic irradiated noises to the motor
19. Line filter EMC/RFI for EASYMAT applications
20. Electrical connection scheme
21. Plant conversion scheme
22. Pump installation scheme
 - 22.1. One pump installation scheme
 - 22.2. Two pump installation scheme
23. Declaration of conformity

1. Introduction

We strongly suggest that the operator carefully reads and follows the information contained in this instruction manual for the frequency converter.

Symbol used:



This symbol indicates **high voltage hazard**. It draws attention to components or procedures that could represent a potential danger to the health and welfare of the operator.



This symbol is used to draw the operator's attention to situations of potential danger for people or for operations that could cause damage to the product.



The maximum output frequency must not exceed the design frequency of the pump being controlled. Operating at a frequency higher than the allowable frequency can cause higher current absorption and damage to the device.



If it is necessary to remove the frequency converter, remove only the covers required in order to disconnect the electrical cables. Take care not to damage the electronic cards.



Failure to comply with the safety regulations not only causes risk to personal safety and damage to the equipment, but also invalidates every right to assistance under warranty.

2. Special warnings regarding the frequency converter



We strongly suggest that the operator carefully reads and follows the information contained in this instruction manual for the frequency converter.



The **FREQUENCY CONVERTER should NEVER be opened or tampered with and guards that come with it should never be removed.**



The frequency converter must be installed, adjusted and maintained by qualified personnel who understand the risks involved.



The frequency converter must be fitted with voltage surge and overload protection devices, in accordance with the prevailing safety standards.



The connection of the alarms can distribute power even when the frequency converter is turned off. Ensure that there is no residual voltage on the terminals of the alarms.



All the power terminals and other terminals must be inaccessible after installation is completed.

Electro-magnetic compatibility.

The frequency converter is constructed in compliance with European standard 2004/108CE.

Responsibility:

The manufacturer is not liable for malfunctioning if the product has not correctly been installed, damaged, modified, and/or run outside the recommended work range or not in accordance with other indications given in this manual.

The Manufacturer declines all responsibility for possible errors in this instructions manual, if due to misprint or error in copying.

The Manufacturer reserves the right to make any modifications to products that it may consider necessary or useful, without affecting the essential characteristics.

The responsibility of the manufacturer is limited to the product and excludes costs or greater damage caused by incorrect installation.

3. Types

| Type | Frequency converter | Standard power |
|----------------|---------------------|----------------|
| (single-phase) | max current output | V230 motor |
| | A | kW |
| Easymat 5MM | 5 | 0,37 - 0,55 |
| Easymat 9,2MM | 9,2 | 0,75 - 1,1 |

| Type | Frequency converter | Standard power |
|---------------|---------------------|----------------|
| (three-phase) | max current output | V230 motor |
| | A | kW |
| Easymat 5MT | 5 | 0,75 - 1,1 |
| Easymat 7,5MT | 7,5 | 1,5 - 1,8 |
| Easymat 9,2MT | 9,2 | 2,2 |

4. Operating conditions

(Standard execution)

The electrical panel functions correctly under the following power and installation characteristics:

- Power fluctuation: +/-10% max
- Frequency fluctuations: +/- 4 % max
- Ambient temperature: -10 °C a + 40 °C
- Relative humidity: from 20% to 90% without condensation
- Vibration: max 5,9 m/s² (0,6 g) to 10-55 Hz
- Altitude: no higher than 1000 m, inside a closed environment.
- Max liquid temperature:
 - 50 °C EASYMAT 5MM, 9,2MM, 5MT, 9,2MT
 - 40 °C EASYMAT 7,5MT
- Minimum delivery: 3 l/min



The current distributed by the frequency converter must be equal to or lower than the maximum current absorbed by the motor to control.

5. Construction

(Standard execution)

The system is composed of:

- Frequency converter.
- Pressure transducer.
- Pipe housings.
- Fixing screws.
- Terminal board.
- Cable glands.
- Multi-hole gaskets.

5.1. Technical features

Power supply interface: 230V ± 10%

Protection: IP55

Display: LCD Display

Keyboard: 6 buttons

Digital inputs: - float switch for dry-running protection
- tank fill float switch
- safety pressure switch

Analogue inputs: pressure transducer 4-20 mA

Digital outputs: general alarm, the display shows the type of alarm (see paragraphs 7.6. and 9.3.)

Connectivity: RS485

Protections: - dry-running protection
- over-current
- over-heating
- under-voltage and over-voltage
- short-circuit protection on the motor phase

5.2. Pushbuttons functions



Through this button you can start the pump.



Through this button you can stop the pump.



Through this button you have access to frequency converter programming parameters. If you already are on the programming function, by pushing this button you go up on the menu.



Through this button you have access to frequency converter programming parameters. If you have changed a parameters, by pushing this button you can confirm the indicated value.



Through this button you can increase parameters or to change the visualized parameter.



Through this button you can decrease parameters or to change the visualized parameter.

5.3. Interface

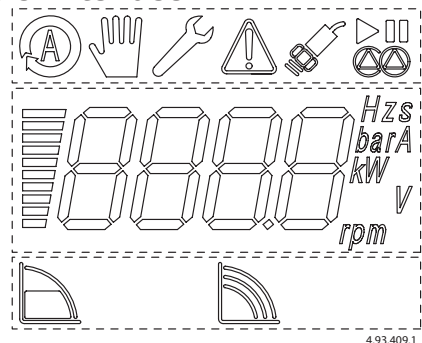

The graphic interface of the display is divided in three visualization areas: - system icons
- display area
- operating icons

5.3.1. System icons



AUTO MODE

The system is operating in auto mode.



MANUAL MODE

The system is operating in manual mode.



SET-UP MODE ACTIVATED

It shows that the set-up menu is activated. When a icon is blinking you are modifying a parameter. You can confirm with  enter.



ALARM

It indicates that there is a fault on the system, the error number appears on the display area. When you are on the set-up mode the alarm icon will not appear



SENSOR STATE

It indicates that the system is connected with the pressure transducer; if it is blinking there is a fault on the pressure transducer.



PUMP STATE

It indicates if the pump is running or in stand-by state.



CASCADE MODE

It indicates that the cascade control mode is working. The 2 upper symbols show if the pump is running or if the pump is in stand-by. The lower symbol informs if the pump is the master (lighted icon) or slave (blinking icon).

5.3.2. Display area

It is composed from an incremental bar proportional with the displayed value and its measure unit. The display is backlit, the light will be turn off after 20s of system inactivity.

5.3.3. Operating icons



Constant pressure mode

The system keeps the pressure constant when the quantity of water requested by the user changes.



Fixed speed mode

The system works at a fixed speed that user can choose according to need.

5.4. Submersible pumps applications or long cables

To operate a submerged pump (or surface pump), where the distance from the inverter is more than 10 m, see paragraph 18.



Submersible motor must operate with a frequency between 30 Hz (minimum operating frequency) and 50 Hz (maximum frequency) for 50 Hz motors, and between 30 and 60 Hz for 60 Hz motors.



The running up time from 0 to 30 Hz and the running down time from 30 Hz and 0, must be as short as possible, according to the motor power to operate.

6. Installation

For easy assembling and disassembling of the frequency converter we recommend to respect the minimum distances as show in figure herebelow.

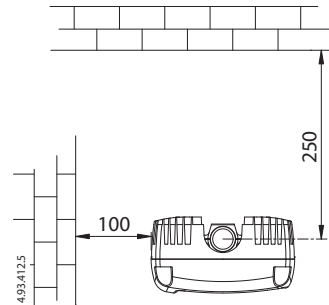

In case of reduced distances connect the frequency converter with the proper unions (see paragraph 16.3.).

Do not install the control panel in places exposed to direct sunlight or near sources of heat.

Fasten the heatsink (a) to the pipe by means of the pipe housings (b1-b2) and the screws (c) in equipment.

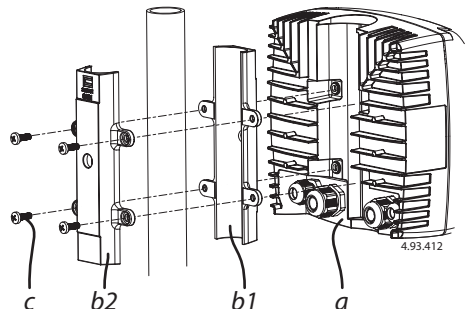

The pressure transducer (*d*) must be installed on the system. We always advise the installation of a small accumulator (*e*) (8 ltrs minimum) on the pump delivery side.

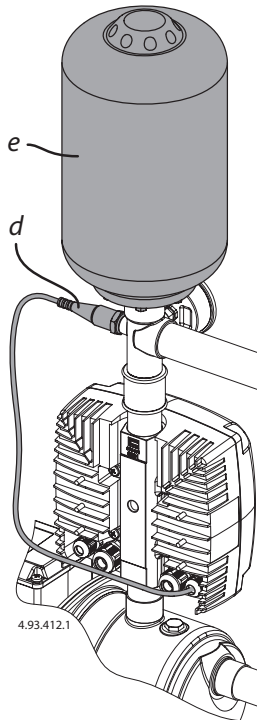

7. Electrical connection

 Electrical connection must be carried out by a qualified electrician in accordance with local regulations.

Follow all safety standards.

The unit must be properly earthed (grounded).

Follow the instructions in the wiring diagram attached.

 Once the electrical connection has been completed, remove any pieces of wire, sheath, washers or any other foreign bodies that may be found inside the frequency converter.

 For the electrical connections on both the terminal board and the motor use cable with a maximum section of 2,5mm². We also advise the use of insulated pin terminals.

 Bad connections may damage the electronic circuit.

7.1. Power supply line

Power supply line must comply with the provisions under paragraph 4.

 If a differential protection is necessary, install a type **A differential switch**, protected against untimely activation and with threshold of intervention of 30 mA.

Electrical connection

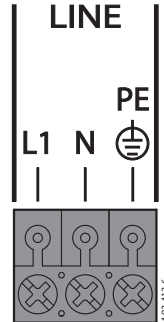

7.2. Motor connection

The power supply line of the electrical motor must be connected directly to the output terminal of the inverter.

 To comply with the standards of electromagnetic compatibility, use a shielded three-pole cable (for MM models) or a shielded four-pole cable (for MT models) with external protection sheath.

The power supply line of the motor must never run parallel to the power line of the electrical panel.

Electrical connection

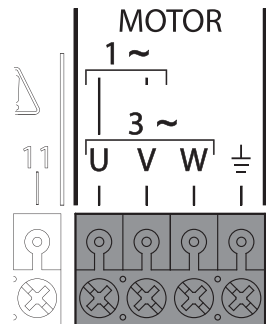

7.3. Pressure transducer

The pressure transducer is an analogical instrument with an output signal of 4-20 mA that continuously reads the pressure in a system.

Features:

- Standards: EN 50081-1, EN 50082-2.
- Voltage: 8-28 V
- Pressure range: 0-6; 0-10; 0-16 bar
- Output: 4-20 mA
- Working temperature: da 0 a +50 °C
- Protection: IP 65
- Hydraulic connection : G 1/4 male
- Weight: ~ 60 g



Electrical connection

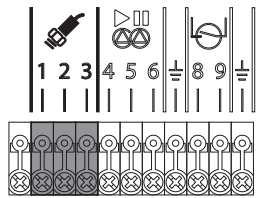

Pressure transducer terminal box supplied by us

7.4. Cascade mode

The EASYMAT frequency converters are prearranged for use in pressure boosting sets with up to 3 pumps in the following versions:

- Pressure boosting sets with 2 variable speed pumps
- Pressure boosting sets with 3 variable speed pumps
- Pressure boosting sets with 1 variable speed pump and 1 fixed speed pump (single-phase)

7.4.1. Cascade mode installation



Connect the frequency converters on the delivery pipes of the pumps, the installation must comply with the provisions under paragraph 6. Connect the pressure transducer to the delivery manifold of the pressure boosting sets.

 It is advised to install the pressure transducers on the same point of the delivery manifold and complete the installation with a pressure gauge.

7.4.2. Cascade mode electrical connection

Connect the supply cables to the motors and to the power supply following the instructions under paragraph 7. The power supply must comply with the provisions of the paragraph 4-5.

 The connection with the power supply must be with interpositions of magnetothermal bipolar switches (one for each frequency converter). For these frequency converters an earth leakage circuit breaker or ground fault circuit interrupter, type B.

This circuit breaker or interrupter must be marked with the following symbols:  

7.4.3. Cascade connection with variable speed pumps

Electrical connection with 2 pumps

By means a proper cable make the connection of the clamps number 4-5-6 of both frequency converters.

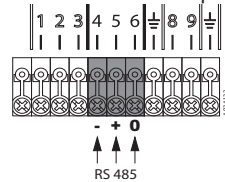



Electrical connection with 3 pumps

By means a proper cable make the connection of the clamps number 4-5-6 of each frequency converter.

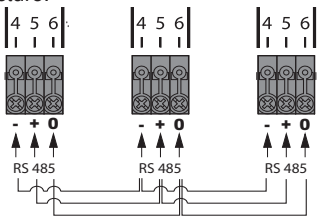
 User must provide a jumper connection into 1 frequency converter as shown in the picture.





 Check the correct connection sequence and check that terminals of each cable are connected on the clamp with same number.  To comply with the standards of electromagnetic compatibility, for cable length greater than 1 meter, it is recommend the use of a shielded cable with protection sheath connected on the ground of both frequency converters.

7.4.4. Cascade connection with 1 variable speed pump and 1 fixed speed pump

Connect the clamps 10-11 with a contactor with max.250 Vac and 450 mA maximum resistive current, connect to the contactor the power supply

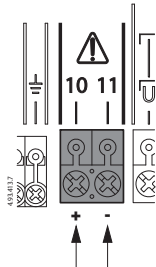
cable and the motor cable of the fixed speed pump.



 The connection with the power supply must be made with interpositions of magnetothermal bipolar switches with proper size and with a type A differential switch protected against untimely activation and with threshold of intervention of 30 mA.

 The use of the cascade mode with 1 fixed speed pump not allow connection of a remote alarm or a control panel remote alarm RA100.

7.4.5. Cascade mode programming

Pressure boosting sets with 2 variable speed pumps.

After the connection, change the AP09 parameter from OFF to UU for both frequency converters, define which frequency converter will work on master mode and for this frequency converter change the AP10 parameter from SLA (slave) to MAS (master).

Pressure boosting sets with 3 variable speed pumps.

After the connection, change the AP09 parameter from OFF to UU for both frequency converters, define which frequency converter will work on master mode and for this frequency converter change the AP10 parameter from SLA(slave) to MAS (master). Then parameter AP15 must be changed for each “slave” frequency converter. The first slave frequency converter must be set as “SLA1”, and the second slave frequency converter must be set as “SLA2”.

For the right behavior of the booster set it is recommended to switch off and switch on all the frequency converter.

 This configuration define an address for each frequency converter, if not correctly configured, cascade mode will not work properly.

Pressure boosting sets with 1 variable speed pump and 1 fixed speed pump (single-phase).

After the connection, change the AP09 parameter from OFF to UF for the frequency converter.

7.4.6. Cascade mode plant starting

Check that all the cascade mode parameters are with the desired values, the parameters that can change the cascade mode operation are:

| | |
|------|---|
| AP16 | Cascade mode start fall pressure set-up |
| AP17 | Cascade mode restart delay |
| AP18 | Cascade mode fall pressure limit set-up |

To do the plant starting follow the instructions under paragraph 12.

7.5. Float switch connection

To connect a float-switch connect to the connections 8-9 the cables of the float switch. The float switch can be used for:

- dry-running protection
- if, in cascade mode, the frequency converter which is connected the float switch is failure, the float switch cannot shut off the pumps.



Electrical connection

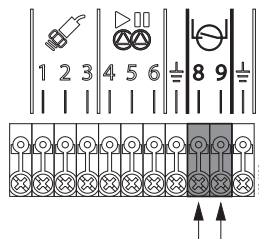

7.6. Remote alarm connection

To connect a remote alarm connect to the connections 10-11 the possible remote alarm or the control panel for remote alarm RA100.

The remote alarm can be used to signal:

- error on the frequency converter (see paragraph 9.3.) (nO).
- the frequency converter is running (nC).



Operating limits: 250 Vac, 450 mA maximum resistive current.

Electrical connection

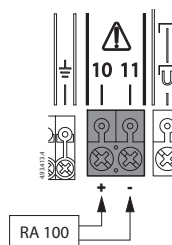

8. Dry-running protection

The frequency converter is equipped with a dry-running protection for the pumps. When the pressure on the system remain for a time higher than the dry-run time (AP05) lower than value of the dry-run pressure (AP07) the protection system stop the pump. It is possible the use of an external float switch for the dry-running protection (see paragraph 7.5.). In this case the pumps start with a delay time (in seconds) defined by AP19 (Digital input restart time), the time will be counted after the change of the float switch state. For entering the programming mode see paragraph 10.

9. Parameters



On the frequency converter the following informations are displayed:

- Parameters of pump status.
- Programming parameters.
- Alarms.

9.1. Parameters of pump status

They allow to visualize:

- the modulation frequency of the pump (basic display).
- the pressure of the system.
- the line absorbed current.

Starting from the basic display by pushing of the directional arrow  (plus) or  (minus) the other parameters are displayed.

Example:



9.2. Programming parameters

To display the programming parameters, select  (menu).

Will be displayed progressively:

UP - User settings: these are the basis settings that user can change.

AP - Advanced settings: these settings are available only to qualified personnel. To enter password is required (see paragraph 10.1.).



SA - Technical assistance settings: these are the advanced parameters, only technical assistance personnel are allowed to access this menu. Password is required (see paragraph 10.1.).

MAN - Fixed speed mode activation: this allows activation of the fixed speed mode and the working frequency. Only qualified personnel are allowed to access this menu. Password is required (see paragraph 10.1.).

AE - Advanced parameters: this allows for the display of secondary parameters which can be useful for system diagnostics.

| | |
|------|--------------------|
| AE01 | Software release |
| AE02 | Supply voltage (V) |
| AE03 | Last 5 faults |

Supply voltage visualization example.

By pushing the  button (menu) the UP parameter appears. Select the AE parameter by pushing the  (plus) up to arrive at the correct

parameter , confirm with  (enter).

Select the parameter  by pushing the button  (plus) and confirm with  (enter). Supply voltage is displayed.

9.2.1. UP – User settings

| N° | Description | Standard | Modifications | Note |
|------|--|----------|---------------|------|
| UP01 | restart mode power failure [rA = automatic; rM = manual] | rA | | |
| UP02 | Nominal pump current (A) | 0,1 | | |
| UP03 | Nominal pump frequency (Hz) | 50 | | |
| UP04 | Direction of rotation [---☐ = std rotation; ☐--- = inverted rotation] | ---☐ | | |
| UP05 | Set point pressure (bar) | 1,5 | | |

9.2.2. AP – Advanced settings

To enter password is required (see paragraph 10.1.)

| N° | Description | Standard | Modifications | Note |
|------|--|--------------|---------------|------|
| AP01 | Pressure transducer set-up (bar) [sensor full-scale] | 10 | | |
| AP02 | Ramp down (s) | 3 | | |
| AP03 | Ramp-up (s) (fixed value for MM) | 2 MT 0 MM | | |
| AP04 | Time before stop (s) | 30 | | |
| AP05 | Dry-run time (s) | 10 | | |
| AP06 | First dry-run time (s) | 60 | | |
| AP07 | Dry-run pressure (bar) | 1,5 | | |
| AP08 | System dynamic [1 = fast dynamic; 5 = slow dynamic] | 3 | | |
| AP09 | Cascade mode [oFF; UU = cascade mode with double inverter; UF = cascade mode with an inverter] | oFF | | |
| AP10 | Master/Slave setting MAS = master; SLA = slave | SLA | | |
| AP11 | Reset to factory set-up | | | |
| AP12 | Digital input activation [0 = oFF; 1 = no; 2 = nC] | 1 | | |
| AP13 | Digital output activation [0 = oFF; 1 = on; 2 = no; 3 = nC] | 0 | | |
| AP14 | Restart fall pressure set-up (bar) | | | |
| AP15 | Pump address | SLA1 | | |
| AP16 | Cascade mode start fall pressure set-up (bar) | 0,3 | | |
| AP17 | Cascade mode restart delay (s) | 10 | | |
| AP18 | Cascade mode fall pressure limit set-up (bar) | 0,6 | | |
| AP19 | Digital input delay time (s) [float switch delay time] | 30 | | |

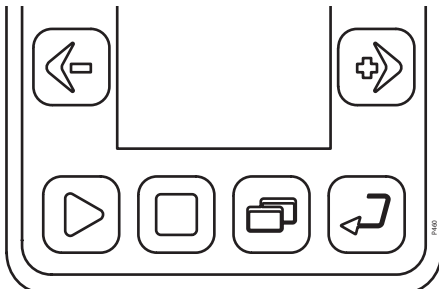

9.2.3. SA – Technical assistance settings

To enter password is required (see paragraph 10.1.)

| N° | Description | Standard | Modifications | Note |
|------|---|----------|---------------|------|
| SA01 | | | | |
| SA02 | | | | |
| SA03 | Pressure PID (Proportional gain) | 2,8 | | |
| SA04 | Pressure PID (Integral time constant) | 5,5 | | |
| SA05 | Pressure PID (Derivative time constant) | 5,0 | | |
| SA06 | Min. run frequency (Hz) | 30 | | |
| SA07 | Max frequency (Hz) | 60 | | |
| SA08 | Set point pressure step up (bar) | 0,3 | | |
| SA09 | Pressure step up time (s) | 3 | | |
| SA10 | Pressure step up ramp (bar/s) | 0,3 | | |
| SA11 | Set point control ramp (bar/s) | 0,4 | | |
| SA12 | Carrier frequency | 7010 | | |
| SA13 | Singlephase starting frequency (Hz) | 80 | | |
| SA14 | Singlephase starting voltage (V) | 195 | | |
| SA15 | Nominal voltage (V) | 220 | | |

9.2.4. MAn – Fixed speed mode activation



To enter password is required (see paragraph 10.1.)

| N° | Description | Standard | Modifications | Note |
|------|--------------------------------------|----------|---------------|------|
| MAn1 | Fixed speed mode activation | oFF | | |
| MAn2 | Working frequency [MAn2 ≤ UP03] (Hz) | 45 | | |











9.3. Alarms



| N° | Displayed alarm | Causes |
|------|---|---|
| Er01 | Blockage due to no water | The device is in failure due to no water. The system try to restart automatically. - One attempt every 10 minutes for 6 times. - One attempt every hour for 24 times. - One attempt every 24hours for 30 times. |
| Er02 | Pressure transducer fault | Not connected cable, broken connection, pressure transducer spoiled. |
| Er03 | Blockage due to low supply voltage | Supply voltage lower than 190V. - The system automatically restart when the clamp voltage is higher than 190V. |
| Er04 | Blockage due to high rectified voltage | Supply voltage higher than 250V. - The system automatically restart when the clamp voltage is lower than 250V. |
| Er05 | Blockage for memory failure | |
| Er06 | Blockage due to overcurrent in the electro pump motor | |
| Er07 | Blockage due to overcurrent in the frequency converter | |
| Er08 | Blockage due to direct short circuit between the phases of output terminals | |
| Er09 | Blockage due to overheating | |
| Er10 | Blockage due to overheating of the power module | |
| Er11 | Blockage due to low voltage 24 V | |
| Er12 | Stop for float switch intervention | The system will restart with a delay defined by AP19 from the state variation of the float switch. The control panel for remote alarm not report this alarm. |
| Er13 | Internal hardware error | Contact the technical assistance |
| Er14 | Cascade mode communication error | Check the RS 485 connection or that both pumps are enabled. |



In case of multiple fault, scroll with the buttons  (plus) or  (minus) to visualize the fault sequence.
In case of thermal block it is advised to check the causes that have created the problem before restart the pump operation.











10. Programming



To enter programming, select  (menu). Use the buttons  (plus) or  (minus) to move to the programming parameter to be modified and select  (enter) to confirm. Use the buttons  (plus) or  (minus) to move to the parameter to be modified and select  (enter) to confirm, with the buttons  (plus) or  (minus) increase or decrease the value. From this moment the set-up icon  start blinking until the value is confirmed with  (enter).

To exit the program, push  (menu) until when you arrive on the basic display. When you go in the set-up mode appear the icon .



Example of parameter variation.

In order to modify the set point pressure from 3.0 bars to a 2.8 bars:



select  (menu) and then with the buttons  (plus) or  (minus) until you move to programming parameter UP. Confirm with  (enter) and then with the buttons  (plus) or  (minus) move to the parameter UP05. Confirm with  (enter) and then with the buttons  (plus) or  (minus) change the value up to the desired value. From this moment the set-up icon  start blinking until the value is confirmed with  (enter).

To exit the program, push  (menu) until you arrive on the basic video, when you are out from the set-up mode the icon disappear .

10.1. PASSWORD insertion

To enter on a menu with password, four numbers appear on the display, the number to insert is blinking. By pushing buttons  (plus) or  (minus) you can change the blinking value. If you confirm with  (enter) the next number start blinking.

If the password is correct you can enter on the MENU, if the password is wrong the first number restart blinking.

To exit the program, push  (menu) until you arrive on the basic display, when you are out from the set-up mode the icon disappear .

| password | value |
|----------------------|----------------------------------|
| user | 1959 |
| Technical assistance | contact the technical assistance |

11. Parameters to check when starting up the unit

There are 4 programming parameters that need to be checked when the unit is started up:

• Parameter UP02 NOMINAL PUMP CURRENT

The nominal current of the pump must be set.



If the value input is inappropriate there is the risk of pump damage or to have an unexpected overcurrent alarm.

• Parameter UP03 NOMINAL PUMP FREQUENCY



The nominal frequency of the pump must be set.



If the value input is inappropriate there is the risk of higher current absorption or pump damage.

• Parameter UP05 SET POINT PRESSURE

The working pressure of the pump must be set.

If the value input is inappropriate for the needs of the system, the value can be increased or decreased using the  (plus) or  (minus) keys.



If during the first start-up of the unit, filling the system takes longer than 1 minute and the unit signals a dry-running alarm, Increase the parameter AP06, until the pressure rises above the set value and the pump remain on. (Make sure the pump are primed).

11.1. Vessel pressure



Once the new working pressure is entered, the tank pre-loaded pressure must be changed to be 2/3 of the working pressure (i.e. 4 bar working pressure, tanks to be pre-loaded at 2.7 bar).

12. Plant starting



ATTENTION: never run the pump dry not even for a short trial run. Start the pump after filling completely with liquid.

After completing hydraulic and electrical connection and checked the preloaded pressure (for booster set with membrane tank), start the plant as indicated below:

Prime the pumps (see the pumps instructions).

Pump with suction lift:

- Fill the suction pipe and the pump body by means of the plug hole located close to the delivery port of the pump.
- Fill the suction tube by pouring water through the plug hole on the suction manifold of the pump.

Pump with positive suction head:

- Open the gate-valve in the suction pipeline. With sufficient head, the water will overcome the resistance of the non-return valve fitted in the suction side of the pump and will fill the pump body. Otherwise, prime the pump with the plug hole near the delivery port.



Never run the pump for more than five minutes with closed gate valve.

Starting pump

When the frequency converter is switched on, the pump are not operating and on the screen appears OFF.

Press the button  (play) to change the pump status from STOP to run. The pump starts up with the acceleration ramp set to reach the wished pressure.











When the motor starts turning, check the direction of rotation.

If the pump has been primed correctly, after a few seconds the pressure will begin to increase on the display.

If, after a few seconds, operation the pressure remains at 0.0, stop the pump by selecting  (stop) as priming has not been carried out correctly and the pump is idling. Re-prime the pump and repeat the starting up procedure.

12.1. Inversion of the direction of rotation

To change the direction of rotation of the motor, push the button  (menù) and then with the button  (plus) move up to the programming parameter UP. Confirm with  (enter) and with the button  (plus) move up to the parameter UP04, confirm with enter  (enter) and by pushing of the button  (plus) change the value, confirm with  (enter). To exit the program, push  (menù) until you arrive on the basic display, when you are out from the set-up mode the icon disappear .

13. Operations

The frequency converter is programmed to manage the automatic operation of 1 or 2 pumps, all at variable speed.

Depending on user consumption, the pumps start to guarantee the amount of water necessary at the set pressure.

When one pump has reached 50 Hz and water requirements increase, the second pump will begin operations.



The pumps are protected against:

- operation when dry, by means of a floating switch and level sensor,
- over/under voltage (frequency converter),
- thermal overload (frequency converter).

13.1. Quick set point modification

If the frequency converter is operating in constant pressure mode it is possible to change the set point pressure without enter on the user

parameter (UP menu). Pushing the button  (enter) for more than 5 seconds you will enter directly to the set point pressure (UP05 parameter).

By pushing of the buttons  (plus) or  (minus) change the pressure value and confirm with  (enter).

By pushing of the button (menu) the system will return to the basic display (see paragraph 9.1.).

14. Use of megaohmmeter

Megging of an installation incorporating the frequency converter is not allowed, because the electronics may be damaged. If megging is necessary, disconnect the frequency converter and use the megaohmmeter directly on the terminal box of the pump.

15. Maintenance



Inspect the tank pre-loaded pressure of the delivery vessel periodically.

16. Accessories

16.1. RA 100

Control panel for remote alarm.

Dimensions: 110x150x70

Power supply: 220-230 V single-phase

Signals all pump assembly malfunctions detected:

- No water intake.
- Assembly malfunction.
- Converter failure.

5-Watt flashing red light plus 75 dB - 3600 Hz acoustic alarm, for use in areas of loud noise, positioned in such a way as to be visible from a distance.

The control panel is fitted to an energized panel led and an alarm reset pushbutton.



RA 100

16.2. Pipe housings kit

Pipe housings for G1, G1 1/4 and G1 1/2 pipes.

For the G1 1/2 version of the EASYMAT it is required change the screws assembled on the heatsink with the screws provided with the G1 1/2 pipe housing kit.

16.3. Unions kit

Steel pipe with unions and pressure transducer arrangement.

17. Disposal

Observe the local regulations and dispose of any control gear accordingly. This product contains electrical and electronic components and should be disposed of accordingly.

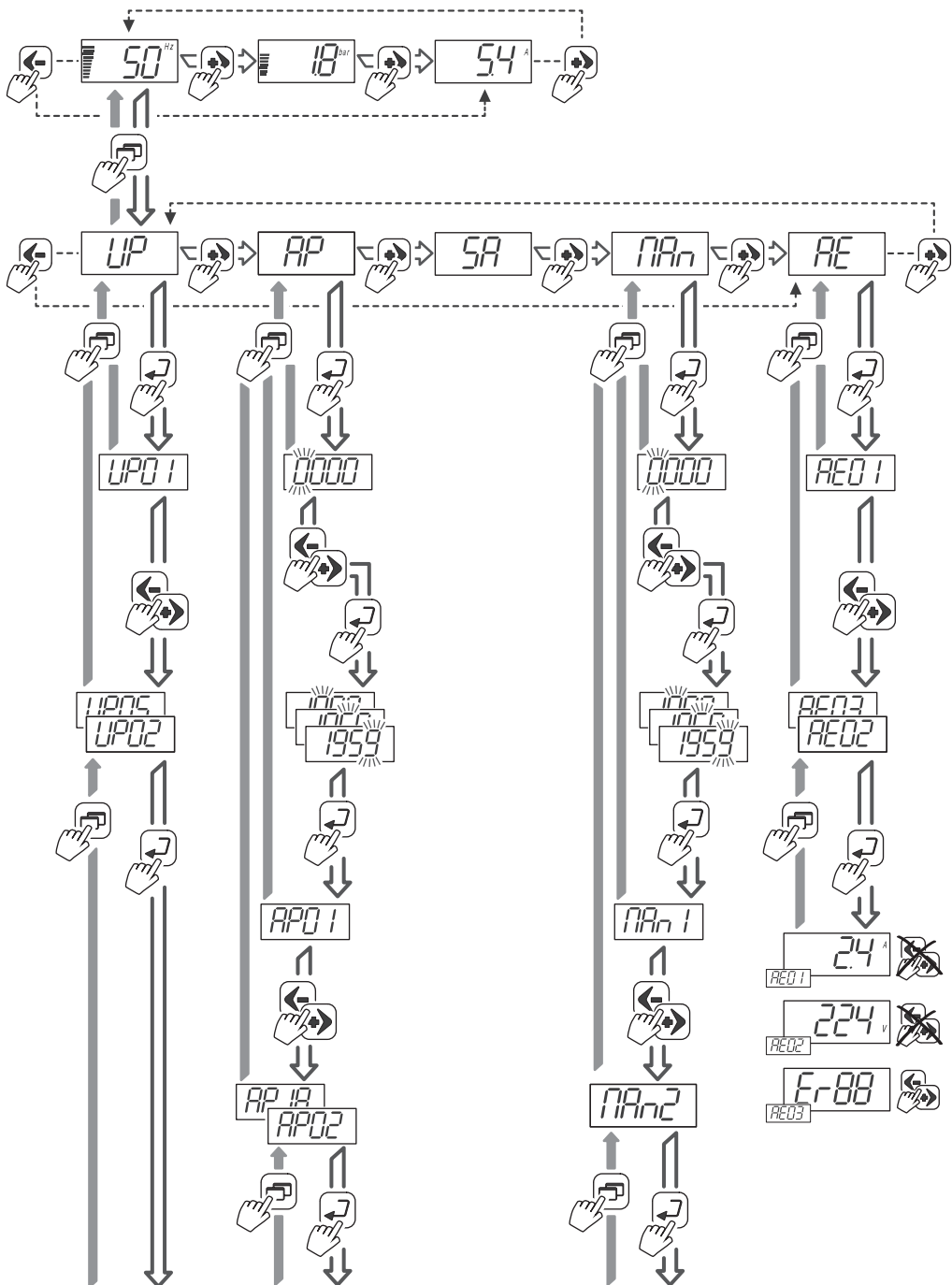

Modifica parametro - Change parameter - Changement de paramètre
 Cambio de parámetros - Parameterwert ändern - изменение параметра

